

# JESI 2D

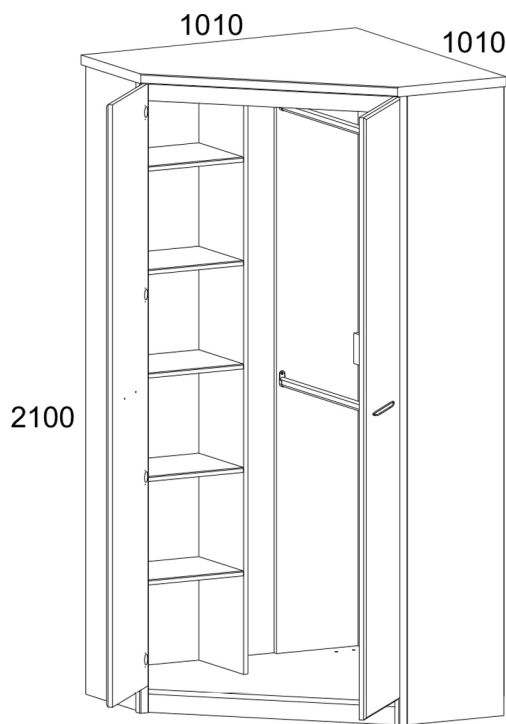

## Navodila za uporabo.

Priporočljivo je, da ob nakupu razpakiranega izdelka v trgovini preverite njegovo kakovost in popolnost. Izdelek je treba sestaviti tako, kot je opisano v tem priročniku. Medtem ko je izdelek v uporabi, je treba občasno zategniti ohlapne vijačne povezave. Če je treba premikati predmete po stanovanju, morate pred premikanjem izdelek popolnoma sprostiti z bremena (ležišča). Da bi preprečili poškodbe obstoječih nosilcev, je treba izdelek pred premikanjem dvigniti. Pohištvo ne sme biti izpostavljeno stiku z vodo. Brisanje prahu iz izdelka je treba opraviti z rahlo vlažno mehko krpo. Da bi preprečili deformacijo delov in spremembo barve izdelkov, pohištva ne nameščajte na neposredno sončno svetlobo.

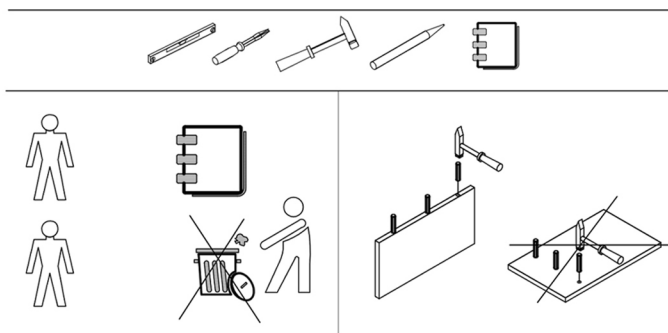



















Medtem ko je izdelek v uporabi, je **PREPOVEDANO**:

- nameščati pohištvo v bližini grelnih naprav, blizu surovih sten in v prostorih z relativno vlažnostjo nad 70 %;
- segrevati elementov pohištva na temperaturo, višjo od 40 C;
- med sestavljanjem in uporabo kompleta izdelkov stopati na vodoravne ščite in okna;
- uporabljati kemičnih čistil za čiščenje pohištva;

## Garancija proizvajalca.

1. Garancijski rok za uporabo izdelka - 24 mesecev od datuma prodaje. V garancijskem roku proizvajalec zagotavlja popravilo ali zamenjavo izdelkov, če uporabnik ni kršil pravil uporabe.
2. Reklamacije mora potrošnik vložiti neposredno pri trgovski organizaciji, v kateri je bilo pohištvo kupljeno, pri čemer mora predložiti "Navodila za uporabo" in kopijo potrdila o prodaji.
3. Izdelek, bočna omara 3D2S, ki je del sklopa "JAZZ", izpolnjuje 2 zahteve standarda GOST 16371-2014, TR TS 025/2012.
4. Življenjska doba pohištva je 5 let.
5. Proizvajalec si pridržuje pravico do sprememb v zasnovi izdelka, ne da bi pri tem ogrozil njegove zahteve glede zasnove in uporabe.
6. Za sestavljanje izdelkov je priporočljivo pritegniti usposobljeno osebje. To je pomembno! Navodila shranite za primer ponovne montaže pohištva ali reklamacije. Pri uveljavljanju reklamacije uporabite zapis iz navodila.

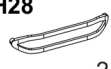
Koda	Dimenzije				paket
7	1010	1010	32	1	1/4
55	400	300	16	5	1/4
56	977	977	16	1	1/4
126	2064	394	32	1	2/4
127	2064	394	32	1	2/4
139	961	100	16	1	1/4
153	1988	300	16	1	3/4
155	1988	300	16	1	3/4
215	410	1974	16	2	3/4
255	100	60	16	1	1/4
271	865	60	16	2	1/4
354	2014	714	2,5	1	4/4
355	2014	988	2,5	1	4/4
Y2	955			2	1/4

<b>A1</b>  20	<b>A2</b>  20	<b>S5</b>  8	<b>S8</b>  2
<b>R24</b>  7x50 6	<b>G</b>  1,5x26 70	<b>S3</b>  8	<b>Q</b>  2
<b>I</b>  1	<b>C1</b>  8x35 22	<b>N1</b>  5	<b>E5</b>  8
<b>A8</b>  20	<b>A7</b>  20	<b>Y1</b>  4	<b>D1</b>  8
<b>R102</b>  3,5x16 35	<b>R3</b>  3x20 8	<b>R23</b>  6,3x13 16	<b>H28</b>  2
			<b>M4</b>  M4x22 4

**I**

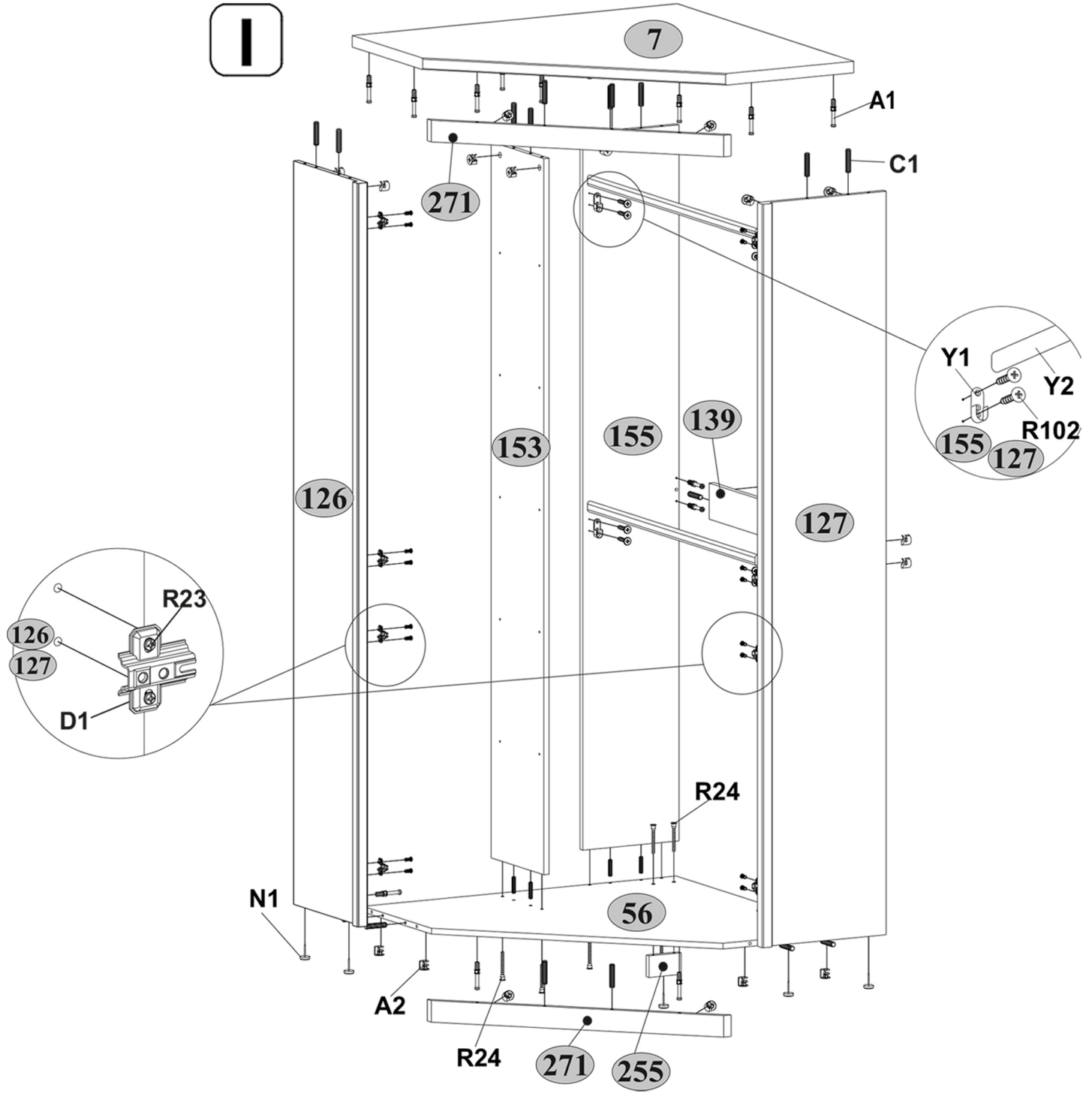

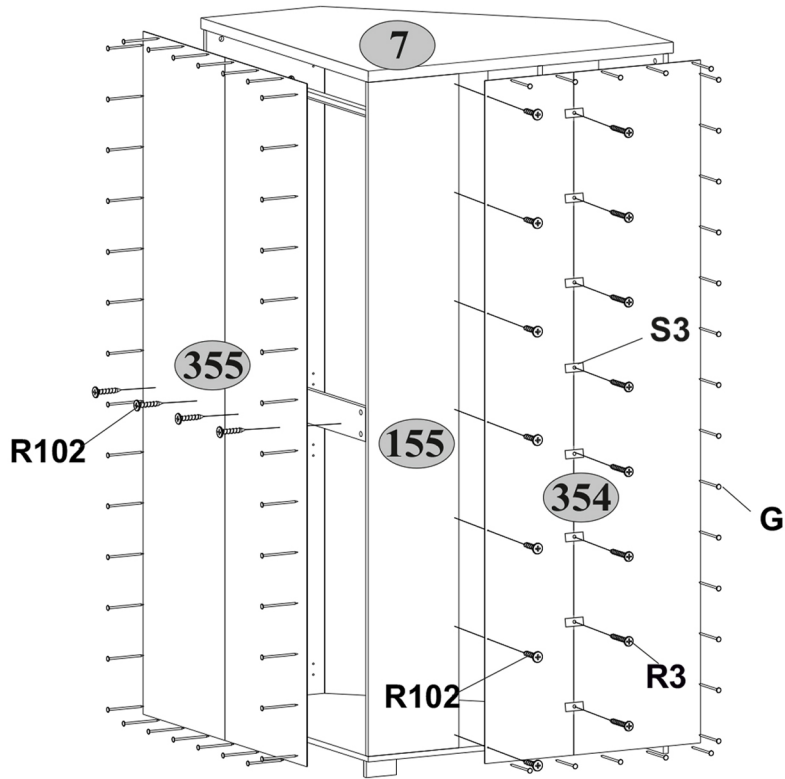

 max.  
5 kg

 max.  
15 kg

E5+R102

